

**OLYMPUS**<sup>®</sup>

Your Vision, Our Future

<http://www.olympus.com>

Linear PCM Recorder

**LS-10**

How to Capture  
Live Sound



# Experience the world of unlimited live sound recording with the LS-10

Fully compliant with the linear PCM format, the LS-10 is capable of non-compressed digital audio recording at 96 kHz/24-bit for better-than-CD quality. This outstanding quality makes it possible to capture live sound just as it is with near-absolute fidelity.

For stable, reliable performance, the LS-10 features built-in microphones accommodated in machined aluminum housings. Superior audio quality is further assured by using separate boards for the microphone amplifier circuitry's system control and audio control operations, thereby minimizing internally generated noise.

Despite its compact, lightweight, go-anywhere design, the LS-10 delivers pro-standard high-quality recording and is capable of uninterrupted extended recording for as long as 16 hours\*.

From birdsong to musical performances, the LS-10 makes it easy to record stunning, high-fidelity sound nearly identical to the original.

\* 44.1 kHz/16-bit recording using two AA Ni-MH batteries.



## Features of the LS-10

### Recording in various scenes

- Scene 1: Recording music
- Scene 2: Recording sounds of nature
- Scene 3: Recording a conference

### Setups of musical Instruments

### Actual applications

- Application 1: Digitizing an analog source
- Application 2: Excellent playback functions
- Application 3: Playback, editing on your PC
- Application 4: CD creation on your PC

### Accessories

### Specifications

## High-quality linear PCM recording capability

### High-sensitivity built-in microphones for high-quality recording

Newly developed to accurately capture any type of sound, the LS-10's high-sensitivity microphones are accommodated in vibration-resistant housings made of machined aluminum. The size and aperture shape of the housings are designed to optimize basic microphone performance parameters such as a frequency response and directivity, ensuring maximum quality. To produce recordings with a natural, expansive stereo feel, the left and right microphones are installed in an outward facing layout at angles of 90°.



Low-vibration microphone structure

### High audio quality microphone amplifier circuitry

The microphone amplifier circuitry is divided into independent left and right channels to eliminate interference between channels. The analog circuitry is powered by an independent power supply provided separately from the digital power supply. In addition, the system control (digital processing) and audio processing use independent circuit boards to ensure clear signal transmission and high S/N.

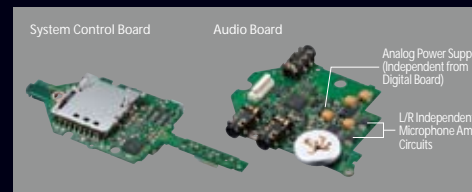

Separate system control (digital)/audio processing boards

### Long-term recording capability

Recording time can be as long as 16 hours with two AA Ni-MH rechargeable batteries or about 12 hours with two AA alkaline batteries (both in the 44.1 kHz/16-bit mode). A built-in 2 GB flash memory enables up to 3 hours 10 minutes of CD quality (44.1 kHz/16-bit) recording or up to 69 hours and 35 minutes of WMA format recording. The LS-10 is also equipped with an SD/SDHC card slot to add additional recording capability.

• See table on page 15 for the reference recording time of each recording mode. • The maximum capacity per file is limited to about 4 GB with the MP3/WMA formats and about 2 GB with the linear PCM (WAV) format. • The maximum recording time per file is about 26 hours 40 minutes with the WMA format. • The recording time available with an SD/SDHC card varies depending on the card. • Check the Olympus website (<http://olympus.com>) for compatible SD/SDHC cards.

### Multi-format compatibility

Supported recording formats include the MP3 and WMA formats that are widely used in Internet file distributions and are suitable for long-term recording, as well as the linear PCM (WAV) format. Select the optimum recording mode according to the purpose and usage of each recording.

Comparison of file capacity between recording formats (Reference values)

Rec Mode	Capacity used per minute	Main purpose
Linear PCM (WAV)	96 kHz/24-bit	Approx. 51 MB
	96 kHz/16-bit	Approx. 26 MB
	48 kHz/24-bit	Approx. 20 MB
	48 kHz/16-bit	Approx. 13 MB
	44.1 kHz/24-bit	Approx. 17 MB
MP3	320 kbps	Approx. 11 MB
	256 kbps	Approx. 2.4 MB
	128 kbps	Approx. 1.9 MB
WMA	160 kbps	Approx. 0.9 MB
	128 kbps	Approx. 0.9 MB
	64 kbps	Approx. 0.5 MB

• The values shown are reference values.

### Recommended setups for different applications

Recording settings can be adjusted to suit the needs of different recording situations. Note that the examples listed in the following table are typical setups that may require further adjustment depending on the target sound source and ambient conditions. Experiment with the different setups and select the most optimum one.

Typical recording settings (Reference values)

Recording Function	Recording Situation					
	Indoor music performance	Band performance in a studio	Performance in a big hall, etc.	Bird songs, train sound, etc.	Small conference or interview	Large conference in a big hall
MIC SENSE	For most applications, LOW is recommended to reduce noise. HIGH is better for capturing quiet sounds or voices.					
LOW CUT	LOW			LOW or HIGH		HIGH
Rec Mode	Linear PCM (WAV) is recommended for audio quality; MP3 or WMA is recommended for longer recording time.			Linear PCM (WAV) format		
Rec Level	MANUAL is recommended for wider dynamic range (such as in live recording), and AUTO is recommended for voices in a conference.			MANUAL (The limiter function can also be set.)		
Zoom Mic	The directivity of the built-in stereo microphones can be adjusted according to the recorded sound source. This adjustment is recommended when there is a specific sound source to be captured, for example when recording a lecture.					



## Scene 1 Recording music

The following settings are recommended for recording musical instruments in a room or studio as well as music recital in a hall.

### Rec Mode setup

Select the recording mode that best corresponds to your requirements and what you intend to do with the recording. For critical recordings that you want to preserve or distribute, the linear PCM (WAV) format is recommended because it offers the truest fidelity to the original sound and is suitable for post-recording processing. If you plan to make a CD later using the recorded data, it is a good idea to select the 44.1 kHz/16-bit setting, which is the same recording format used for music CDs. As the LS-10 is equipped with an SD/SDHC card slot, the available recording time can be increased using a memory card. If you select a compressed audio recording format such as MP3 or WMA, the amount of space required for data recording can be reduced to less than 1/10th of the linear PCM (WAV) format, but it should be noted that the original audio cannot be fully restored once the audio signal has been compressed.

### LS-10 recording position

Place the LS-10 in front of the musical instruments or the stage. The microphones have directivity so they should be installed in front of the performer or stage, with the LCD panel facing up. If the microphones are tilted or placed upside down, the sound source cannot be recorded with correct positioning and the phase may be inverted. For details on the positioning, see pages 10 and 11 of this guide.



Install the LS-10 in front of the musical instruments or stage.

### Recording function setup

The MIC SENSE switch on the side panel can be used to select the sensitivity of the built-in microphones. The LOW position is recommended for most applications because it can record audio with higher S/N and wider dynamic range. The HIGH position is recommended when you need to capture small or ambient sounds.

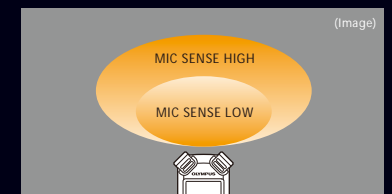

Built-in microphone sensitivity switching

### Rec Level adjustment

Recording level can be selected from AUTO or MANUAL. The MANUAL position is recommended when the priority is on the dynamic range. In this case, the recording level should be adjusted manually using the REC LEVEL dial on the side panel. To prevent the sound from breaking up, adjust the REC LEVEL so that the level meter indicates around -6 dB even at the peak level of sound. If the level meter indicates 0 dB or higher, the PEAK indicator lights and the recorded audio will be distorted. If the limiter function is switched on, audio distortion due to excessive input level can be prevented by maintaining an optimum recording level even when sound with an unexpectedly high level is input.

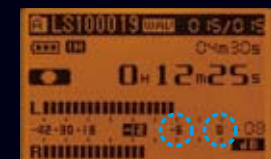

Level meter

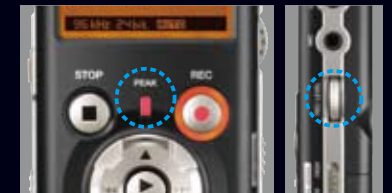

PEAK indicator

REC LEVEL dial

### Tips

#### Using a tripod as a microphone stand

Installing the recorder on a tripod is recommended to prevent grip noise and obtain stable recordings. The LS-10 has a tripod mount hole so that it can be mounted on a tripod designed for use with a camera and its position and angle can be adjusted correctly according to the sound source.

#### Remote control option

The exclusive remote control set (optional RS30W\*) is available for wireless control of the recording start/stop/pause operations of the LS-10. The remote control makes it possible to install the recorder in an ideal position and prevent capturing of grip noise.



## Scene 2 Recording sounds of nature

The following settings are recommended for outdoor recording of sounds of nature such as bird songs, the murmuring of a stream, or even the sound of a steam locomotive.

### Rec Mode setup

When recording bird songs or the sound of a steam locomotive, the linear PCM (WAV) mode is recommended, as it has the capability to capture close-to-original sounds. However, since linear PCM (WAV) format files take up a lot of recording space, it is recommended to use an SD/SDHC card or record audio in the MP3 or WMA format when extended recording is required.

WAV (44.1 kHz/16-bit)	Approx. 3 hr. 10 min.
MP3 (128 kbps)	Approx. 35 hr. 35 min.
WMA (64 kbps)	Approx. 69 hr. 35 min.

Available recording time of internal memory (2 GB) (Reference values)

### LS-10 recording position

The quality of the recorded sound can vary greatly depending on where the LS-10 and/or the microphones are positioned. When recording the sound of a moving steam locomotive, position the built-in stereo microphones of the LS-10 parallel to the rails. The recorded audio will move from the right to the left (or vice versa), providing a dynamic stereo feeling. When the recorder is installed horizontally at ear level, sound close to what you actually hear can be recorded.

### Recording function setup

Set the MIC SENSE switch to HIGH when recording a low-level sound such as birds' songs or murmuring of a stream or to LOW when recording a louder sound such as a steam locomotive. The recommended Rec Level setting is MANUAL.

#### Tips

##### Using windscreen for reducing wind noise

Wind noise in outdoor recording is grating, but the high-sensitivity microphones of the LS-10 also capture soft rustling breezes that are usually not sensed by human ears. This kind of wind noise can be attenuated by attaching the provided windscreen to the LS-10.

##### Using external microphones to accurately capture the target source

If the built-in microphones cannot be placed close enough to the recording target, it is recommended to use external microphones. External microphones with high directivity will be able to capture the target sound clearly even when it is as low as a bird's song. The monopod allows the microphone to approach the target and is therefore useful outdoors.



## Scene 3 Recording a conference

The following settings are recommended for recording people speaking at a conference, forum, lecture, etc.

### Rec Mode setup

Long-term recording of a conference or interview is possible using the MP3 or WMA format. Files recorded in the WMA format can be played back easily on a PC using software such as the Windows Media® Player.

### Recording function setup

The Zoom Mic function makes it possible to capture the sound by selecting the direction and area to be emphasized in recording. To record the speaker's voice clearly in an interview, set the MIC SENSE switch to LOW and approach the microphones to the speaker's mouth. The recommended Rec Level setting is AUTO because this frees you from worrying about recording level adjustment.

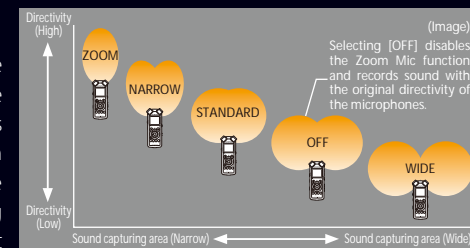

Zoom Mic settings

- When Rec Mode is PCM, the Zoom Mic function can be selected only in the 44.1 kHz/16-bit recording.
- The Zoom Mic function is based on the DVM (DIMAGIC Virtual Microphone) technology of DIMAGIC, Inc.
- Only monaural recording is possible when ZOOM is selected.

#### Tips

##### Using external microphones

Even in a wide conference room, speakers in distant positions can be captured using an optional ME30W 2-channel microphone kit as the external microphones.

##### Benefit of low-cut function in a conference room

The built-in microphones of the LS-10 have such high sensitivity that they tend to capture unnecessary sounds that are usually ignored by the human ear. If this causes a problem, set the LOW CUT switch to ON. This position will effectively cut the continuous low-frequency sounds from air conditioners, LCD projectors, etc.

# Tips for recording individual musical instruments or musical performances

## Vocals

Place the LS-10 some distance in front of the singer(s). If breath noise is noticeable, set the LOW CUT switch to ON or attach the provided windscreen to the LS-10. Adjust the angle of the unit with care as the lowest and highest frequencies may be lost at certain angles.

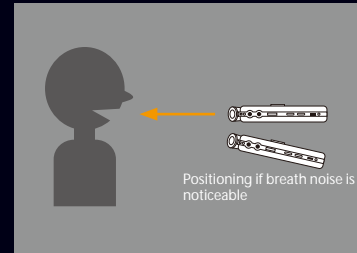

## Acoustic guitar

Point the LS-10 at a point just slightly off the guitar's sound hole. Pointing the unit more toward the saddle will make the sound softer and more reverberant, while pointing it more in the direction of the neck will make the sound sharper and crispier. In general, it is better to put the microphones closer to the guitar when recording the rhythm guitar, and further away when recording the lead guitar playing the main melody.

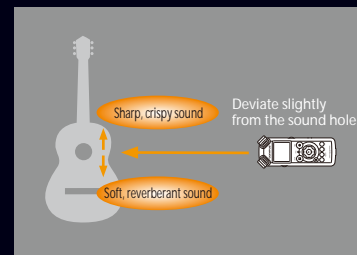

## Sing-along with guitar

Place the LS-10 directly in front of the guitar's sound hole, but point the microphones towards the singer's mouth. This will record the vocal and guitar accompaniment with the optimum balance. If the LS-10 is positioned with one side facing down, the vocal and guitar accompaniment can be distributed to the left and right channels and the balance can be adjusted later.

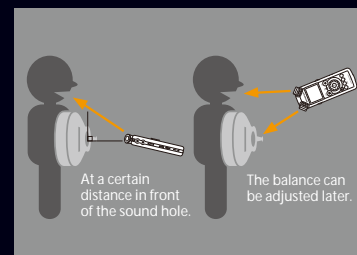

## Wind instrument

Point the LS-10 to the center of the bell. If breath noise is noticeable, point the unit slightly away from the center of the bell. When the recorder's position is off-center line, high frequencies will be more noticeable in the recorded sound. When the recorder is moved closer to the instrument, the recorded sound will have a crisper tone.

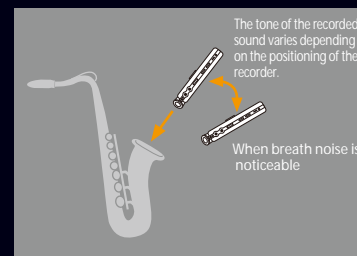

## String instrument

When recording a string musical instrument such as a violin, place the LS-10 above the instrument by pointing it at the f-hole on the body. With a string instrument, decreasing the distance of the LS-10 from the instrument results in a clearer, more contoured sound, while increasing the distance results in a softer sound.

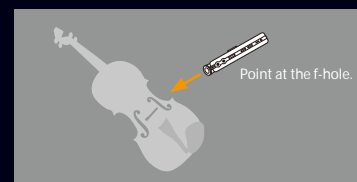

## Piano

With a grand piano, point the LS-10 towards the center of the soundboard located inside the opening of the piano. To include the sounds in the environment where the piano is located, place the microphones further away from the piano so that they can capture the overall sound. As with other instruments, the closer the microphones are to the piano, the clearer the recorded sound, while the further away they are, the softer the sound.

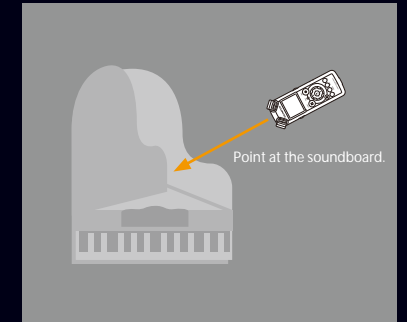

## Electronic keyboard

An electronic musical instrument such as a keyboard does not itself emanate sound so its music signal should be input directly from the LINE OUT jack. An electronic instrument usually uses two 6.3 mm (1/4") dia. standard (phone) plugs for the output, so an adapter cable (commercially available) that can convert the L and R phone plugs into a 3.5 mm (1/8") dia. stereo mini-plug should be used. When the electronic keyboard uses a monaural output or when recording the monaural output of a guitar amplifier, purchase an adapter cable (commercially available) that can convert the 6.3 mm (1/4") dia. monaural phone plug into a 3.5 mm (1/8") dia. stereo mini-plug. It is recommended to use a non-resistance type cable.

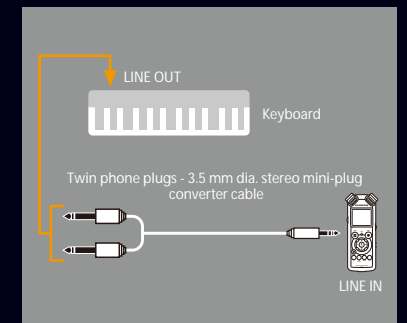

## Electric guitar

To record the sound output from the speaker of a guitar amplifier, place the LS-10 at a distance from the amplifier and point it at the center of the speaker cone. If the guitar amplifier has two speakers, aim the recorder at a central point between the two speakers if you want to record in stereo, or point it at a position slightly away from the center. It is recommended to set the MIC SENSE switch to LOW when recording the sound output from a guitar amplifier. If you want to record the signal output from the LINE OUT directly, connect it in the same way as an electronic keyboard.

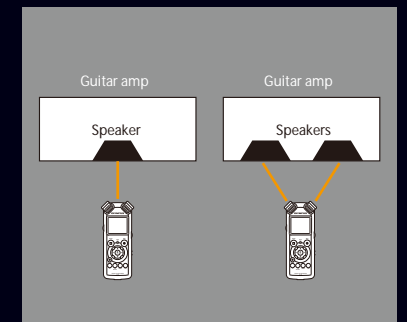

## Recording in a concert hall, etc.

When recording the performance of an orchestra, big band or choir in a concert hall, mount the LS-10 on a stand and place it on the extension of the stage center line, so that all of the performers are included in the microphone directivity coverage.



## Application 1 Digitizing an analog source

The LS-10 can be used to digitize analog sound sources such as LP records and music cassettes. Connect the LINE OUT jacks of the analog component (amplifier, radio-cassette, etc.) to the LINE IN jacks of the LS-10. A converter cable (commercially available) may be required when recording turntable sound through a mini-component system. When using an RCA (pin) jack converter cable, it is recommended to use a non-resistance type cable.

Connecting a compact/portable component

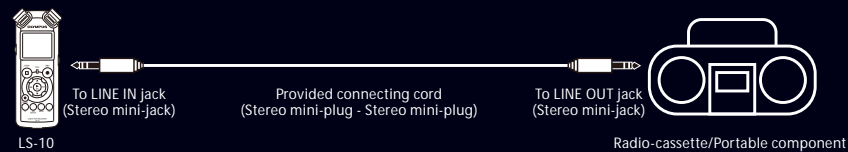

Connecting a mini-component system (turntable)

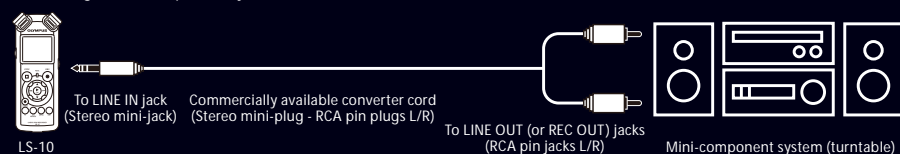

## Application 2 Excellent playback functions

The LS-10 has built-in stereo speakers so that it can reproduce stereo audio without using other devices. The LS-10's ability to play MP3 and WMA format sound files downloaded from a computer and to apply built-in effects also makes it an ideal portable music player. In playback, you can use the Reverb mode to recreate the sound space of various different environments. Five options are available: NORMAL, STUDIO, CLUB, HALL, DOME. The LS-10 also incorporates EUPHONY MOBILE, which offers surround sound with natural expansion for long hours of fatigue-free listening. With a choice of 4 acoustical environment settings including Natural, Wide and Power, as well as Off, this function can dramatically enhance the presence of the sound being listened.

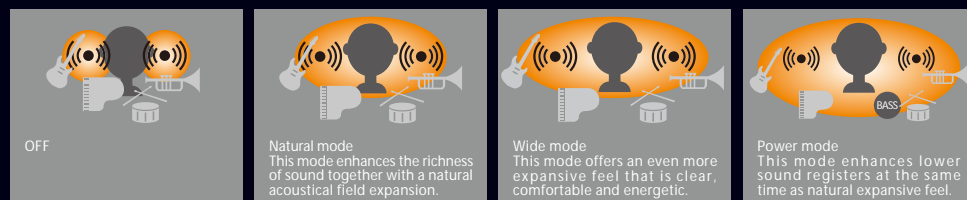

Images of EUPHONY MOBILE settings

• EUPHONY MOBILE is a trademark of comprehensive audio equality improvement technology including the virtual sound source technology of DIMAGIC Corporation.

## Application 3 Playback, editing on your PC

The LS-10 comes with CUBASE LE4 software, a multifunction DAW (Desktop Audio Workstation) application that enables you to edit and play back audio files recorded with the LS-10 on your computer. Editing functions include resizing, division, connection, deletion, fade-in and fade-out. There's also a normalization function that can be used to adjust the recording volume and various effects, enabling you to enjoy high-quality desktop music.



### Main functions

- Editing with max. 48 audio tracks
- Mixer function that can be set per channel.
- Various effects (Delay, Distortion, Dynamics, Filter, Modulation, Reverb, etc.)

### Operating environment

#### Windows

CPU	Pentium / Athlon 1.4 GHz
Memory	512 MB RAM
OS	Windows XP (Home or Professional), Windows Vista
Display	Resolution 1024 x 768 pixels
Audio	Windows DirectX compatible audio
Hardware	ASIO compatible audio hardware recommended for low latency performance
Drive	DVD-ROM drive
Network	Internet access required for license activation

#### Macintosh

CPU	Power Mac G4 1 GHz or Core Solo 1.5 GHz
Memory	512 MB RAM
OS	OS X Version 10.4
Display resolution	1024 x 768 pixels
Hardware	CoreAudio compatible audio hardware
Drive	DVD-ROM drive
Network	Internet access required for license activation



(Project Window)



(VST Dynamics)

Actual applications

## Application 4 CD creation on your PC

You can create original CDs from the recordings you've made with the LS-10. Whether it's your own original musical performances or found sounds such as bird songs, bubbling brooks, or roaring locomotives, burning your recordings to CD is a great way to preserve and share them. If you select the same recording mode used for CDs (44.1 kHz/16-bit) at the time of recording, you can create CDs directly without having to convert the data. Such CDs can be played back on any CD player. To create a CD, upload the recorded audio file to your computer by means of USB connection or an SD card, and burn a CD-R with "Windows Media Player" or "iTunes".

- A CD-R/RW drive is necessary for CD burning.

